

CHAPTER - 14

NETWORKING & OPEN SOURCE CONCEPTS

Question 1:

Identify the Domain name and URL from the following :

<http://www.income.in/home.aboutus.html>

Answer:

Domain name – income.in

URL – <http://www.income.in/home.aboutus.html>

Question 2:

What is Web Hosting?

Answer:

Web hosting is the service that makes our website available to be viewed by others on the Internet. A web host provides space on its server, so that other computers around the world can access our website by means of a network or modem.

Question 3:

What is the difference between packet & message switching ?

Answer:

Packet Switching	Message switching
There is a tight upper limit on the block size. A fixed size of packet is specified.	In message switching there was no upper limit.
All the packets are stored in main memory in switching office.	In message switching packets are stored on disk. This increases the performance as access time is reduced.

Question 4:

Which protocol is used in creating a connection with a remote machine ?

Answer:

Telnet : It is an older internet utility that allow us to log on to remote computer system. It also facilitates for terminal emulation purpose.

Question 5:

Which protocol is used to create a connection with a remote machine? Give any two advantage of using Optical Fibers.

Answer:

Telnet Two advantage of using Optical Fibers are

1. Capable of extremely high speed.
2. No Electromagnetic interference.
3. Extremely low attenuating

Question 6:

What is cloud computing ?

Answer:

The sharing of computer resources (dedicated, time-shared, or dynamically shared servers) and related infrastructure components (load balancers, firewalls, network storage, developer tools, monitors and management tools) to facilitate the deployment and operation of web and network based applications. Cloud computing relies on sharing of resources to achieve coherence and economies of scale, similar to a utility (like the electricity grid) over a network.

Question 7:

Write two characteristics of Wi-Fi.

Answer:

1. It is wireless network.
2. It is for short range.

Question 8:

Expand the following :

1. GSM
2. GPRS

Answer:

1. GSM – Global System for Mobile Communication.
2. GPRS – General Packet Radio Service.

Question 9:

Which type of network out of LAN, PAN and MAN is formed, when you connect two mobiles using Bluetooth to transfer a video

Answer:

PAN

Question 10:

Write one characteristic each for 2G and 3G mobile technologies.

Answer:

2G networks primarily involve the transmission of voice information while 3G technology provides the additional advantage of data transfer.

Question 11:

What is the difference between Packet switching and circuit switching techniques ?

Answer:

In circuit switching, a dedicated path exists from source to destination while in packet switching, there is no fixed path.

Question 12:

Write two advantages of using an optical fibre cable over an Ethernet cable to connect two service stations, which are 200 m away from each other.

Answer:

Advantages of optical fibre :

1. Faster speed than ethernet
2. Lower Attenuation

Question 13:

Write one advantage of bus topology of network. Also illustrate how four (4) computers can be connected with each other using bus topology of network.

Answer:

Advantage (benefits) of Linear Bus Topology is that the cable length required for this topology is the least compared to the other networks.

Bus Topology of Network:

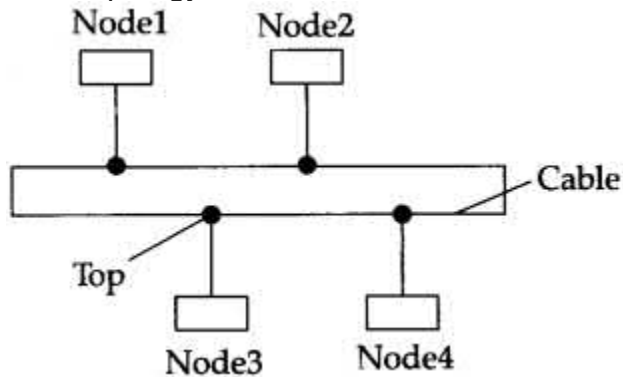

Question 14:

Give one suitable example of each URL and Domain Name.

Answer:

URL: <http://waltons.in>

Domain Name: gmail.com

Question 15:

Write one advantage of star topology of network ? Also, illustrate how five (5) computers can be connected with each other using star topology of network.

Answer:

Advantage (benefits) of star topology:

Easy to replace, install or remove hosts or other devices.

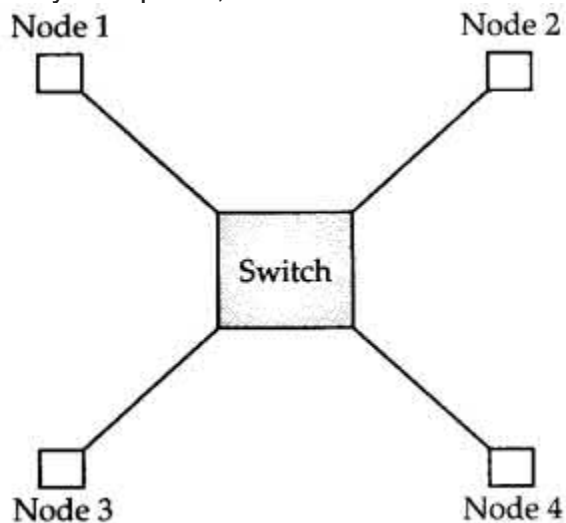

Question 16:

Identify the type of topology on the basis of the following :

(a) Since every node is directly connected to the server, a large amount of cable is

needed which increases the installation cost of the network.
(b) It has a single common data path connecting all the nodes.

Answer:

- (a) Star Topology
- (b) Bus Topology

Question 17:

Expand the following :

- (a) VOIP
- (b) SMTP

Answer:

- (a) Voice Over Internet Protocol
- (b) Simple Mail Transfer Protocol

Question 18:

Daniel has to share the data among various computers of his two office branches situated in the same city. Name the network (out of LAN, WAN, PAN and MAN) which is being formed in this process.

Answer:

MAN

Question 19:

ABC International School is planning to connect all computers, each spread over a distance of 50 metres. Suggest an economic cable type having high speed data transfer to connect these computers.

Answer:

Optical Fibre Cable.

Question 20:

Mahesh wants to transfer data within a city at very high speed. Write the wired transmission medium and type of network.

Answer:

Wired transmission medium – Optical fibre cable Type of network – MAN.

Question 21:

Which device is used to connect all computers inside a lab ?

Answer:

Hub or Switch

Question 22:

Which device is used to connect all computers to the internet using telephone wire ?

Answer:

RJ – 45. It is an eight wired connectors used to connect computers on a LAN.

Question 23:

What is Wi-Fi Card ?

Answer:

Wi-Fi cards are small and portable cards that allow the computer to connect to the internet through a wireless network. The transmission is through the use of radio waves.

Question 24:

Explain the purpose of a router.

Answer:

A router establishes connection between two network and it can handle network with different protocols. Using a routing table, routers make sure that the data packets are travelling through the best possible paths to reach their destination.

Question 25:

Identify the type of topology from the following.

- (a) Each node is connected with the help of a single cable
- (b) Each node is connected with the help of independent cable with central switching.

Answer:

- (a) Bus topology
- (b) Star topology

Question 26:

What is the difference between LAN and MAN ?

Answer:

LAN : It is Local Area Network. The diameter is not more than a single building.

WAN : It is Metropolitan Area Network. LAN spans a few kms while MAN spans 5-50 km diameter and is larger than a WAN.

Short Answer Type Questions-I [2 marks each]

Question 1:

Write any 1 advantage and 1 disadvantage of Bus topology.

Answer:

Advantage : Since there is a single common data path connecting all the nodes, the bus topology uses a very short cable length which considerably reduces the installation cost.
Disadvantage : Fault detection and isolation is difficult. This is because control of the network is not centralized in any particular node. If a node is faulty on the bus, detection of fault may have to be performed at many points on the network. The faulty node has then to be rectified at that connection point.

Question 2:

SunRise Pvt. Ltd. is setting up the network in the Ahmedabad. There are four departments named as MrktDept, FinDept, LegalDept, SalesDept.

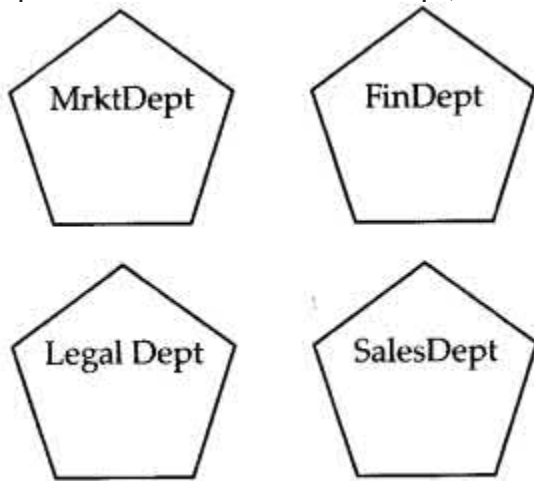

Distance between varioud buldings is as given:

MrktDept to FinDept	80 m
MrktDept to LegalDept	180 m
MrktDept to SalesDept	100 m
LegalDept to SalesDept	150 m
LegalDept to FinDept	100 m
FinDept to SalesDept	50 m

Number of Computers in the buildings :

MrktDept	20
----------	----

LegalDept	10
FinDept	08
SalesDept	42

(i) Suggest a cable layout of connections between the Departments and specify the topology.

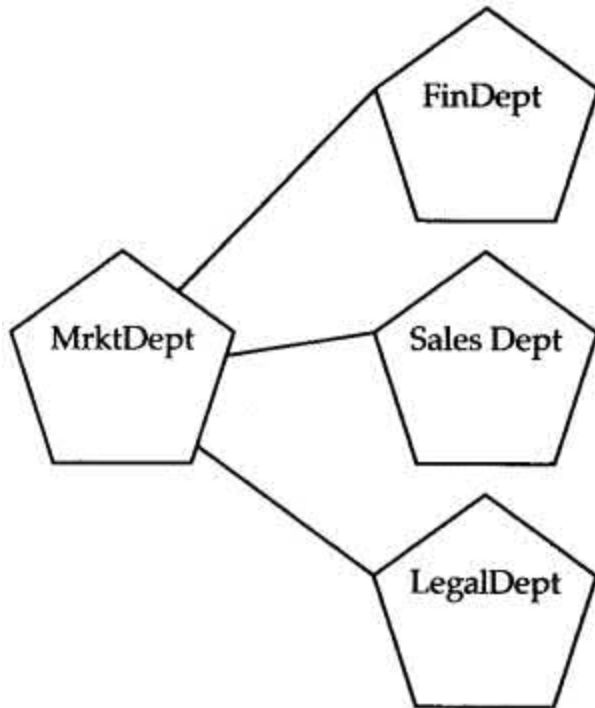

Star Topology should be used.

(ii) Suggest the most suitable building to place the server by giving suitable reason.

Answer:

As per 80 – 20 rule, server should be placed in MrktDept because it has maximum no. of computers.

(iii) Suggest the placement of (i) modem (ii) Hub/ Switch in the network.

Answer:

Each building should have hub/switch and modem in case Internet connection is required.

(iv) The organization is planning to link its sale counter situated in various part of the same city, which type of network out of LAN, WAN, MAN will be formed ? Justify.

Answer:

MAN (Metropolitan Area Network) as MAN network can be carried out in a city network.

Question 3:

Name the protocol

(i) Used to transfer voice using packet switched network.

Answer:

VAns.VOIP (Voice Over Internet Protocol)

(ii) Used for chatting between 2 group or between 2 individuals.

Answer:

IRC (Internet Relay Chat)

Question 4:

What is an IP Address ?

Answer:

IP address is a unique identifier for a node or host connection on an IP network. An IP address is a 32 bit binary number usually represented as 4 decimal values, each representing 8 bits, in the range 0 to 255 (known as octets) separated by decimal points. This is known as "dotted decimal" notation.

Example : 140.179.220.200

Question 5:

What is HTTP ?

Answer:

HTTP is a protocol that is used for transferring hypertext (i.e., text, graphic, image, sound, video, etc.) between 2 computers and is particularly used on the world wideWeb (WWW).

[1 mark for definition/explanation]

Question 6:

Explain the importance of Cookies.

Answer:

When the user browses a website, the web server sends a text file to the web browser. This small text file is a cookie. They are usually used to track the pages that we visit so that information can be customised for us for that visit.

Question 7:

How is 4G different from 3G?

Answer:

3G technology adds multimedia facilities such as video, audio and graphics applications whereas 4G will provide better than TV quality images and video-links.

Question 8:

Illustrate the layout for connecting 5 computers in a Bus and a Start topology of Networks.

Answer:

Bus topology



Star Topology

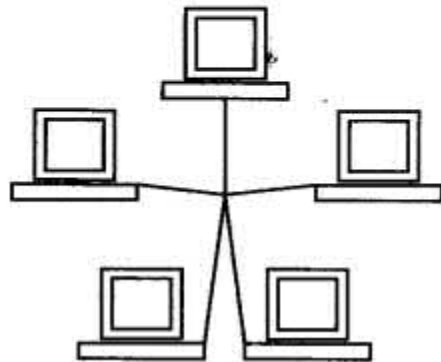

Or any valid illustration of Bus and Star Topology.

Question 9:

What is a spam mail ?

Answer:

Spam is the abuse of electronic messaging systems (including most broadcast media, digital delivery systems) to send unsolicited bulk messages indiscriminately.

Question 10:

Differentiate between FTP and HTTP

Answer:

FTP is a protocol to transfer files over the Internet

HTTP is a protocol which allows the use of HTML to browse web pages in the World Wide Web.

Question 11:

Answer:

following, which is the fastest

1. wired and
2. wireless medium of communication ?

Answer:

1. Wired – Optical Fiber
2. Wireless – Infrared OR Microwave

Question 12:

What is Worm ? How is it removed ?

Answer:

A worm is a self-replicating computer program. It uses a network to send copies of itself to other computers on the network and it may do so without any user intervention. Most of the common anti-virus (anti-worm) remove worm.

Question 13:

Out of the following, which all comes under cyber crime ?

- (i) Stealing away a brand new computer from a showroom.
- (ii) Getting in someone’s social networking account without his consent and posting pictures on his behalf to harass him.
- (iii) Secretly copying files from server of a call center and selling it to the other organization.
- (iv) Viewing sites on a internet browser.

Answer:

(ii) & (iii)

Question 14:

Perfect Edu Services Ltd. is an educational organization. It is planning to setup its India campus at Chennai with its head office at Delhi. The Chennai campus has 4 main buildings – ADMIN, ENGINEERING, BUSINESS and MEDIA. [O.D, 2015]

You as a network expert have to suggest the best network related solutions for their problems raised in (i) to (iv), keeping in mind the distances between the buildings and other given parameters.

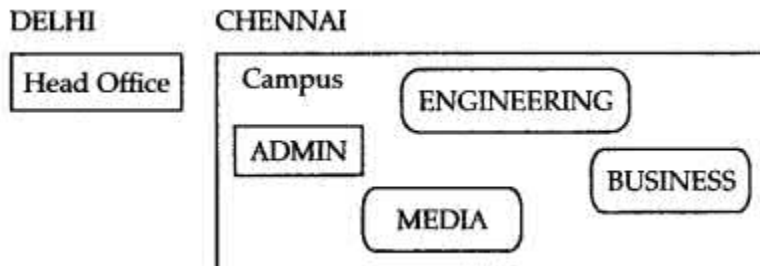

Shortest distances between various buildings.

ADMIN To ENGINEERING	55 m
ADMIN to BUSINESS	90 m

ADMIN to MEDIA	90 m
ENGINEERING to BUSINESS	55 m
ENGINEERING to MEDIA	90 m
BUSINESS to MEDIA	45 m
DELHI Head Office to CHENNAI Campus	2175 km

Number of Computers Installed at various buildings are as follows :

ADMIN	110
ENGINEERING	75
BUSINESS	40
MEDIA	12
DELHI Head Office	20

(i) Suggest the most appropriate location of the server inside the Chennai campus (out of the 4 buildings), to get the best connectivity for maximum no. of computers. Justify your answer.

Answer:

ADMIN (Due to maximum number of computers)

OR

Media (Due to shorter distance from the other buildings)

(ii) Suggest and draw the cable layout to efficiently connect various buildings within the Chennai Campus for connecting the computers.

Answer:

Anyone of the following

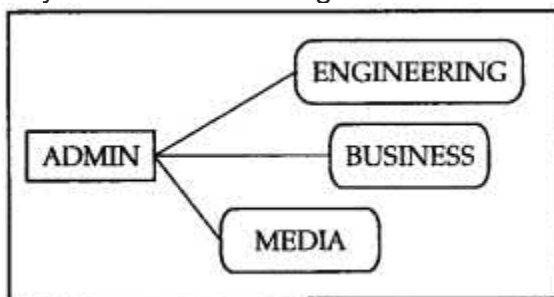

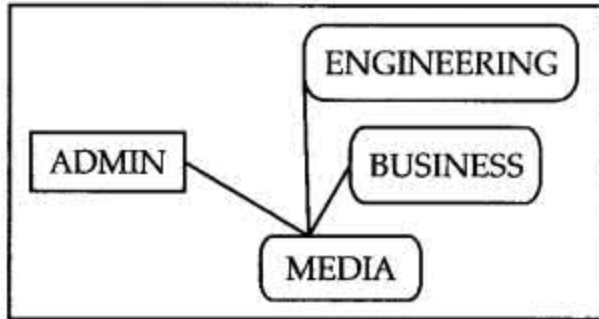

(iii) Which hardware device will you suggest to be procured by the company to be installed to protect and control the internet uses within the campus ?

Answer:

Firewall OR Router

(iv) Which of the following will you suggest to establish the online face-to-face communication between the people in the Admin Office of Chennai Campus and Delhi Head Office ?

Answer:

Cable TV

Question 15:

What kind of data gets stored in cookies and how is it useful ?

Answer:

When a Website with cookie capabilities is visited, its server sends certain information about the browser, which is stored in the hard drive as a text file. It is as way for the server to remember things about the visited sites.

Question 16:

Differentiate between packet switching over message switching ?

Answer:

Packet Switching : Follow store and forward principle for fixed packets. Fixes an upper limit for packet size.

Message Switching : Follows store and forward principle for complete message. No limit on block size.

Question 17:

Out of the following, which is the fastest

(i) wired and

(ii) wireless medium of communication ?

Infrared, Coaxial Cable, Ethernet Cable, Microwave, Optical Fiber

Answer:

- (i) Wired : Optical Fiber
- (ii) Wireless : Infrared OR Microwave

Question 18:

What is Trojan Horse ?

Answer:

A Trojan Horse is a code hidden in a program, that looks safe but has hidden side effects typically causing loss or theft of data, and possible system harm.

Question 19:

Out of the following, which all comes under cyber crime ?

- 1. Stealing away a brand new hard disk from a showroom.
- 2. Getting in someone's social networking account without his consent and posting on his behalf.
- 3. Secretly copying data from server of an organization and selling it to tire other organization.
- 4. Looking at online activities of a friends blog.

Answer:

(ii) & (iii)

Question 20:

Write any two differences between twisted pair and coaxial pair cable.

Answer:

Twisted Pair	Co-axial Cable
Their bandwidth is not as high as coaxial cables.	It has high bandwidth.
A twisted pair consists of two copper wires twisted around each other (each has its own insulation around it) like a double helix.	A coaxial cable consists of a copper wire core covered by an insulating material and a layer of conducting material over that.

Question 21:

Write one advantage of Bus Topology of network, also, illustrate how 4 computers can be connected with each other using star topology of network.

Answer:

Cable length required for this topology is the least compared to other networks.

OR

Any other correct advantage of Bus Topology of network.

Illustration of 4 computers connected with each other using star topology of network.

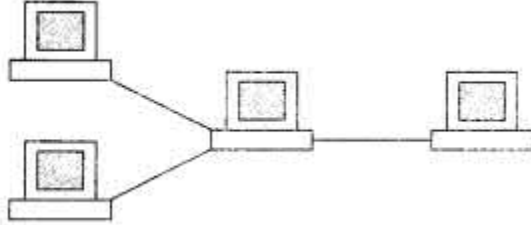

Short Answer Type Question-II [3 marks]

Question 1:

Uplifting Skills Hub India is a knowledge and skill community which has an aim to uplift the standard of knowledge and skills in the society. It is planning to setup its training centres in multiple towns and villages pan India with its head offices in the nearest cities. They have created a model of their network with a city, a town and 3 villages as follows.

As a network consultant, you have to suggest the best network related solutions for their issues/problems raised in (i) to (iv) keeping in mind the distance between various locations and given parameters.

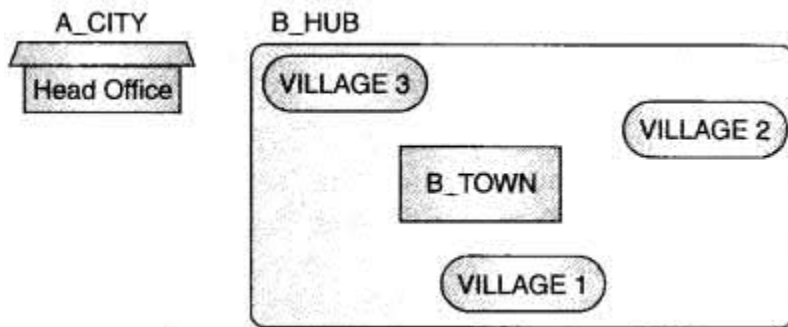

Shortest distance between various location :

VILLAGE 1 to B_TOWN	2 KM
VILLAGE 2 to B_TOWN	1.0 KM
VILLAGE 3 to B_TOWN	1.5 KM
VILLAGE 1 to VILLAGE 2	3.5 KM
VILLAGE 1 to VILLAGE 3	4.5 KM
VILLAGE 2 to VILLAGE 3	2.5 KM
A CITY Head Office to B HUB	25 KM

Number of Computers installed at various locations are as follows :

B_TOWN	120
VILLAGE 1	15
VILLAGE 2	10
VILLAGE 3	15
A_CITY OFFICE	6

Note :

- In Villages, there are community centres, in which one room has been given as training center to this organization to install computers.
- The organization has got financial support from the government and top IT companies.

1. Suggest the most appropriate location of the SERVER in the BHUB (out of the 4 locations), to get the best and effective connectivity. Justify your answer.
2. Suggest the best wired medium and draw the cable layout (location to location) to efficiently connect various locations within the B HUB.
3. Which hardware device will you suggest to connect all the computers within each location of B_HUB ?
4. Which service/protocol will be most helpful to conduct live interactions of Experts from Head Office and people at all locations of B HUB ?

Answer:

- (i) B-TOWN can house the server as it has the maximum no. of computers.
- (ii) Optical fibre cable is the best for this star topology.

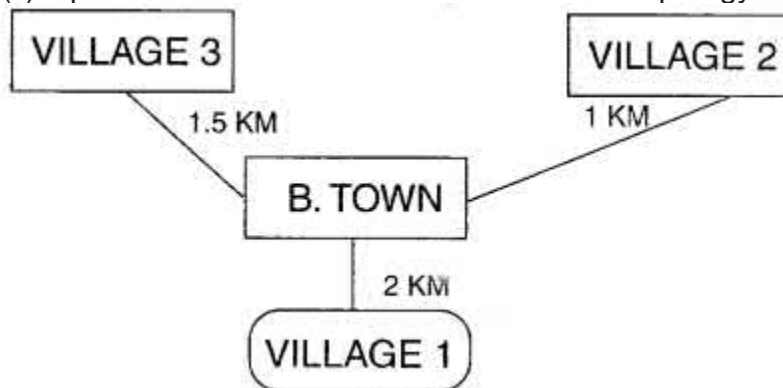

- (iii) Switch
- (iv) VoIP

Long Answer Type Questions [4 marks each]

Question 1:

Indian School in Mumbai is starting up the network between its different wings. There are Four Buildings named as SENIOR, JUNIOR, ADMIN and HOSTEL as shown below.:

SENIOR

JUNIOR

ADMIN

HOSTEL

The distance between various buildings is as follows:

ADMIN TO SENIOR	200m
ADMIN TO JUNIOR	150m
ADMIN TO HOSTEL	50m
SENIOR TO JUNIOR	250m
SENIOR TO HOSTEL	350m
JUNIOR TO HOSTEL	350m

Number of Computers in Each Building :

SENIOR	130
JUNIOR	80
ADMIN	160
HOSTEL	50

(b1) Suggest the cable layout of connections between the buildings.

(b2) Suggest the most suitable place (i.e., building) to house the server of this school, provide a suitable reason.

(b3) Suggest the placement of the following devices with justification, i Repeater i Hub/Switch

(b4) The organisation also has inquiry office in another city about 50-60 km away in hilly region. Suggest the suitable transmission media to interconnect to school and inquiry office out of the following : i Fiber optic cable, i Microwave, i Radiowave

Answer:

(b1)

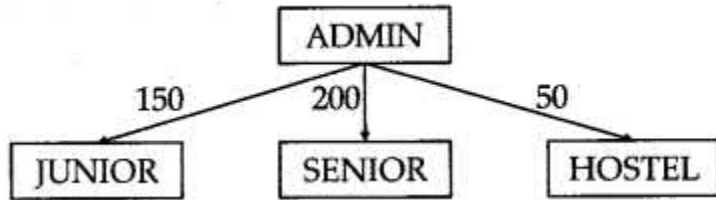

(b2) Server can be placed in the ADMIN building as it has the maximum number of computers.

(b3) Repeater can be placed between ADMIN and SENIOR building as the distance is more than 110 m.

(b4) Radiowaves can be used in hilly regions as they can travel through obstacles.

Question 2:

Vidya Senior Secondary Public School in Nainital is setting up the network between its different wings. There are 4 wings named as SENIOR(S), JUNIOR(J), ADMIN(A) and HOSTEL(H).

Distance between various wings are given below :

Wing A to Wing S	100 m
Wing A to Wing J	200 m
Wing A to Wing H	400 m
Wing S to Wing J	300 m
Wing S to Wing H	100 m
Wing J to Wing H	450 m

Wing	Number of Computers
Wing A	20
Wing S	150
Wing J	50
Wing H	25

(ii) Name the most suitable wing where the Server should be installed. Justify your answer.

(iii) Suggest where all Hub(s)/Switch(es) should be placed in the network.

(iv) Which communication medium would you suggest to connect this school with its

main branch in Delhi ?

Answer:

(i) Star Topology

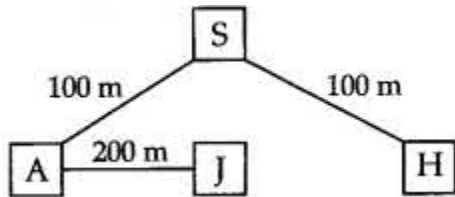

(ii) Server should be in Wing S as it has the maximum number of computers.

(iii) All Wings need hub/switch as it has more than one computer.

(iv) Since the distance is more, wireless transmission would be better. Radiowaves are reliable and can travel through obstacles

Question 3:

Trine Tech Corporation (TTC) is a professional consultancy company. The company is planning to set up their new offices in India with its hub at Hyderabad. As a network adviser, you have to understand their requirement and suggest them the best available solutions. Their queries are mentioned as (i) to (iv) below.

Physical Locations of the blocks of TTC

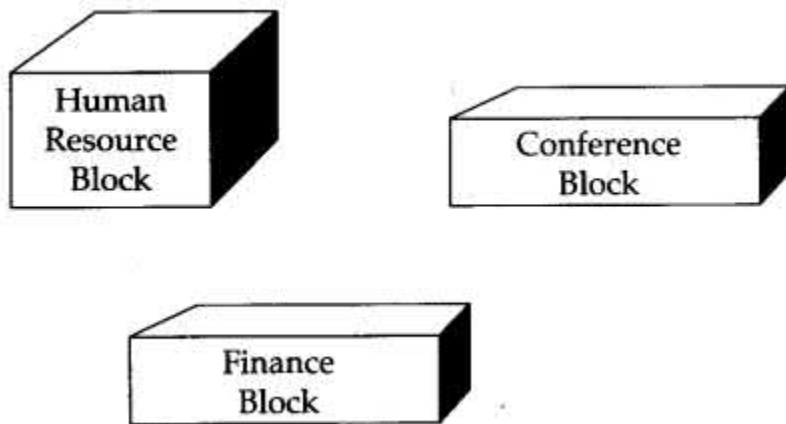

Block to Block distances (in Mtrs.)

Block (From)	Block (To)	Distance
Human Resource	Conference	110
Human Resource	Finance	40
Conference	Finance	80

Expected Number of Computers to be installed in each block

Block	Computers
Human Resource	25
Finance	120
Conference	90

1. What will be the most appropriate block, where TTC should plan to install their server?
2. Draw a block diagram showing cable layout to connect all the buildings in the most appropriate manner for efficient communication.
3. What will be the best possible connectivity out of the following, you will suggest to connect the new setup of offices in Bangalore with its London based office.
 - Satellite Link
 - Infrared
 - Ethernet Cable
4. Which of the following device will be suggested by you to connect each computer in each of the buildings?
 - Switch
 - Modem
 - Gateway

Answer:

- (i) Finance block because it has maximum number of computers.
(ii)

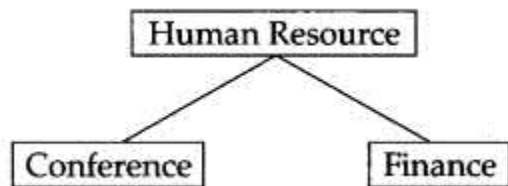

- (iii) Satellite link
(iv) Switch

Question 4:

Tech Up Corporation (TUC) is a professional consultancy company. The company is planning to set up their new offices in India with its hub at Hyderabad. As a network adviser, you have to understand their requirement and suggest them the best available solutions. Their queries are mentioned as (i) to (iv) below.

Physical Locations of the blocks of TUC

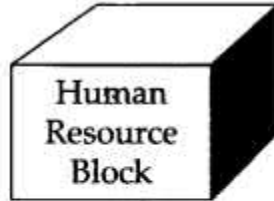

Block to Block distances (in Mtrs.)

Block (From)	Block (To)	Distance
Human Resource	Conference	60
Human Resource	Finance	120
Conference	Finance	80

Expected Number of Computers to be installed in each block

Block	Computers
Human Resource	25
Finance	120
Conference	90

1. What will be the most appropriate block, where TUC should plan to install their server?
2. Draw a block to block cable layout to connect all the buildings in the most appropriate manner for efficient communication.
3. What will be the best possible connectivity out of the following you will suggest to connect the new setup of offices in Bangalore with its London based office?
 - Infrared
 - Satellite Link
 - Ethernet Cable
4. Which of the following devices will be suggested by you to connect each computer in each of the buildings?
 - Gateway
 - Switch
 - Modem

Answer:

- (i) Human resource block because it has maximum number of computers.
- (ii)

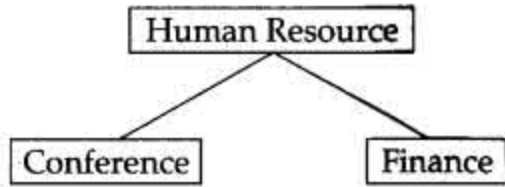

- (iii) Satellite link
- (iv) Switch

Question 5:

G.R.K International Inc. is planning to connect its Bengaluru Office Setup with its Head Office in Delhi. The Bengaluru Office G.R.K. inter-national Inc. is spread across an area of approx. 1 square kilometer, consisting of 3 blocks – Human Resources, Academics and Administration.

You as a network expert have to suggest answers to the four queries (i) to (iv) raised by them.

Note : Keep the distance between blocks and no. of computers in each block in mind, while providing them the solutions.

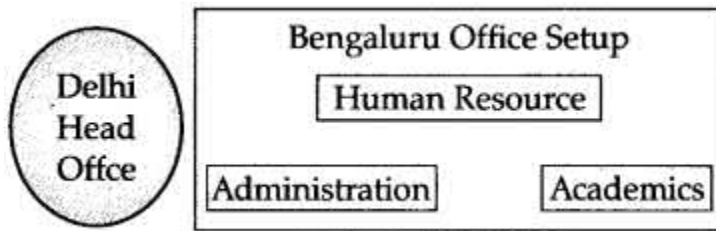

Shortest distances between various blocks :

Human Resources to Administration	100 m
Human Resources to Academics	65 m
Academics to Administration	110 m
Delhi Head Office to Bengaluru Office Setup	2350 km

Number of Computers installed at various blocks are as follows:

BLOCK	No. of Computers
Human Resources	155
Administration	20
Academics	100
Delhi Head Office	20

1. Suggest the most suitable block in the Bengaluru Office Setup, to host the server. Give a suitable reason with your suggestion.
2. Suggest the cable layout among the various blocks within the Bengaluru Office Setup for connecting the Blocks.
3. Suggest a suitable networking device to be installed in each of the blocks essentially required for connecting computers inside the blocks with fast and efficient connectivity.
4. Suggest the most suitable media to provide secure, fast and reliable data connectivity between Delhi Head Office and the Bengaluru Office Setup.

Answer:

- (i) Human Resources because it has maximum number of computers.
(ii)

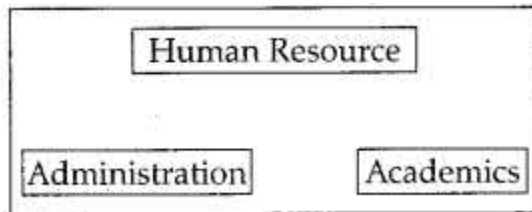

- (iii) Switch
(iv) Satellite link

Question 6:

Rovenza Communications International (RCI) is an online corporate training provider company for IT related courses. The company is setting up their new campus in Kolkata. You as a network expert have to study the physical locations of various blocks and the number of computers to be installed. In the planning phase, provide the best possible answers for the queries (i) to (iv) raised by them.

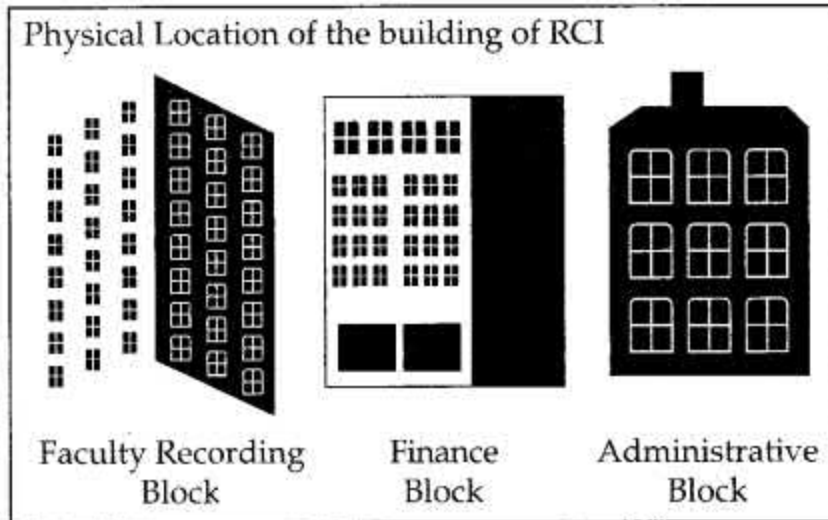

Block to Block Distances (in Mtrs.)

From	To	Distance
Administrative Block	Finance Block	60
Administrative Block	Faculty Recording Block	120
Finance Block	Faculty Recording Block	70

Expected Computers to be installed in each block

Block	Computers
Administrative Block	30
Finance Block	20
Faculty Recording Block	100

1. Suggest the most appropriate block, where RCI should plan to install the server.
2. Suggest the most appropriate block to block cable layout to connect all three blocks for efficient communication.
3. Which type of network out of the following is formed by connecting the computers of these three blocks?
 - LAN
 - MAN
 - WAN
4. Which wireless channel out of the following should be opted by RCI to connect to students from all over the world?
 - Infrared
 - Microwave
 - Satellite
5. Write two advantages of using open source software over proprietary software.
6. Which of the following crime(s) does not come under cybercrime ?

1. Copying some important data from a computer without taking permission from the owner of-the data.
2. Stealing keyboard and mouse from a shop.
3. Getting into unknown person's social networking account and start messaging on his behalf.

Answer:

(i) Faculty Recording Block.

(ii) Bus Topology

Administrative
Block

Faculty Recording
Block

Finance Block

(iii) LAN

(iv) Satellite connection

(v) Advantages of open source over proprietary software :

- Open source software's source code is available, can be modified copied & distributed while propriatary software can't be change.

- Open source is free while propriatary is paid.

(vi) (ii) Stealing keyboard & mouse from-a shop.

Question 7:

(a) What is the difference between domain name and IP address?

(b) Write two advantages of using an optical fibre cable over an Ethernet cable to connect two sendee stations, which are 190 m away from each other.

(c) Expertia Professional Global (EPG) is an online, corporate training provider company for IT related courses. The company is setting up their new campus in Mumbai. You as a network expert have to study the physical locations of various buildings and the number of computers to be installed. In the planning phase, provide the best possible answer for the queries (i) to (iv) raised by them.

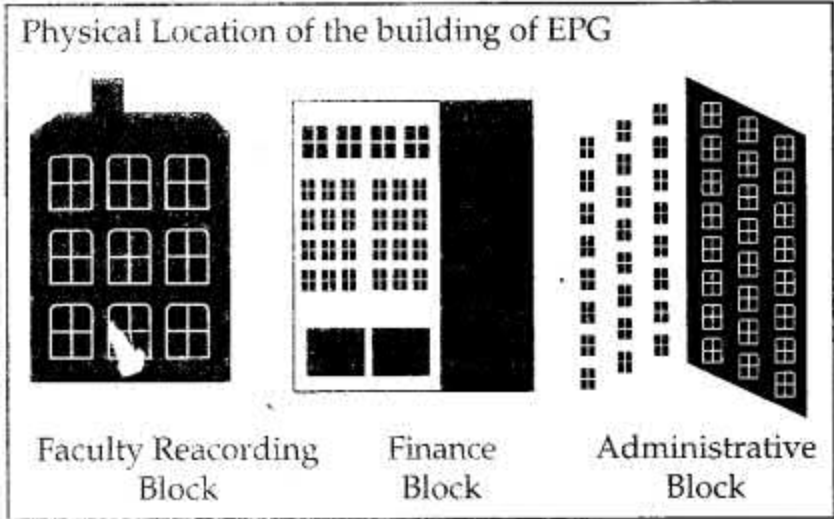

Building to Building Distances (in Mtrs.)

From	To	Distance
Administrative Building	Finance Building	60
Administrative Building	Recording Studio Building	120
Finance Building	Faculty Studio Building	70

Expected Computers to be installed in each Building:

Building	Computers
Administrative Building	20
Finance Building	40
Faculty Studio Building	120

1. Suggest the most appropriate building, where EPG should plan to install the server.
2. Suggest the most appropriate building to building cable layout to connect all three buildings for efficient communication.
3. Which type of network out of the following is formed by connecting the computers of these three buildings?
 - LAN
 - MAN
 - WAN
4. Which wireless channel out of the following should be opted by EPG to connect to students of all over the world?
 - Infrared
 - Microwave
 - Satellite

Answer:

(a) Domain Name is alphanumeric address of a resource over network IP address is a Numeric Address of a resource in a Network. Example :

Domain Name

WWW.Gabsclasses.com

IP Address

102.112.0.153

(b) Optical fibre Advantages :

(i) Faculty Studio Building.

(ii) Bus Topology.

Faculty Finance

Administrative Building

Studio Building

(iii) LAN

(iv) Satellite

Question 8:

To provide telemedicine faculty in a hilly state, a computer network is to be setup to connect hospitals in 6 small villages (V1, V2, ..., V6) to the base hospital (H) in the state capital. This is shown in the following diagram.

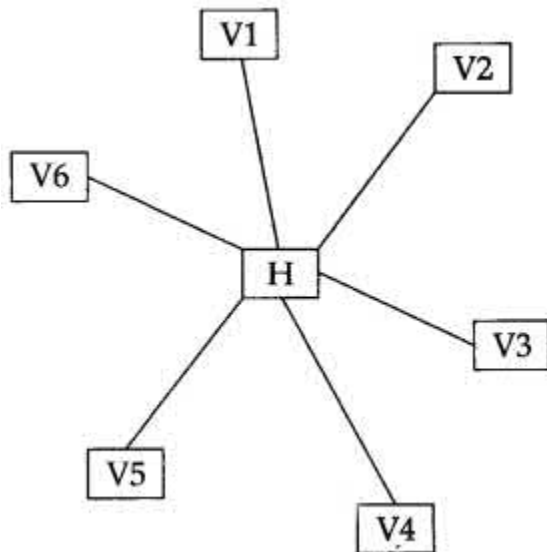

No village is more than 20 km away from the state capital.

Imagine yourself as a computer consultant for this project and answer the following questions with justification :

1. Out of the following what kind of link should be provided to setup this network :
 1. Microwave link,
 2. Radio Link,
 3. Wired Link ?
2. What kind of network will be formed; LAN, MAN, or WAN ?

3. Many times doctors at village hospital will have to consult senior doctors at the base hospital. For this purpose, how should they contact them: using email, sms, telephone, or video conference ?
4. Out of SMTP and POP3 which protocol is used to receive emails ?
5. What are cookies in the context of computer networks?
6. Rajeshwari is trying for on-line subscription to a magazine. For this she has filled in a form on the magazine's web site. When she clicks submit button she gets a message that she has left e-mail field empty and she must fill it. For such checking which type of script is generally executed; client side script or server-side script ?
7. Mention any one difference between free-ware and free software.

Answer:

- (i) Radio Link
- (ii) MAN
- (iii) e-mail
- (iv) POP3
- (v) Cookies are files that store user information that is used to identify the user when he logs into the system.
- (vi) Server-side script.
- (vii) Freeware is a software that has the user to get unlimited usage. Free software may be free for a certain period only.

Question 9:

Work a lot Consultants are setting up a secured network for their office campus at Gurgaon for their day-to-day office and web-based activities. They are planning to have connectivity between three buildings and the head office situated in Mumbai. Answer the questions (i) to (iv) after going through the building positions in the campus and other details, which are given below:

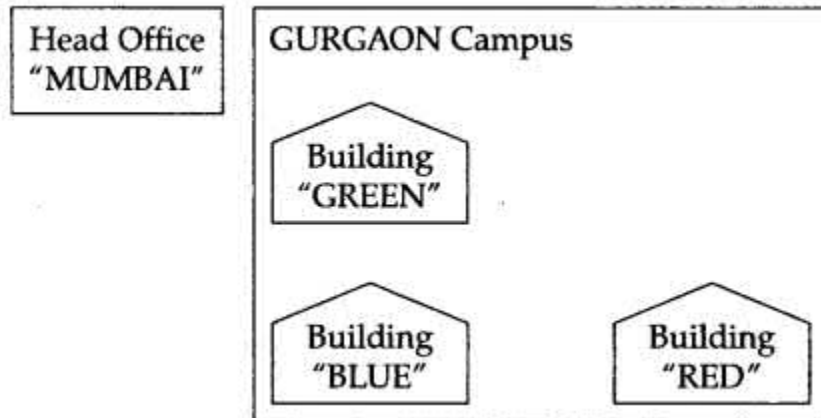

Distances between various buildings :

Building "GREEN" to Building "RED"	110 m
Building "GREEN" to Building "BLUE"	45 m
Building "BLUE" to Building "RED"	65 m
Gurgaon Campus to Head Office	1760 km

Number of computers

Building "GREEN"	32
Building "RED"	150
Building "BLUE"	45
Head Office	10

1. Suggest the most suitable place (i.e., building) to house the server of this organization. Also give a reason to justify your suggested location.
2. Suggest a cable layout of connections between the buildings inside the campus.
3. Suggest the placement of the following devices with justification:
 1. Repeater.
 2. Switch.
4. The organization is planning to provide a high speed link with its head office situated in Mumbai using a wired connection. Which of the following cables will be most suitable for this job ?
 1. Optical Fibre
 2. Coaxial Cable
 3. Ethernet Cable

Answer:

(i) The most suitable place to install server is building "RED" because this building has maximum computer which reduce communication delay.

(ii) Cable layout is Bus topology

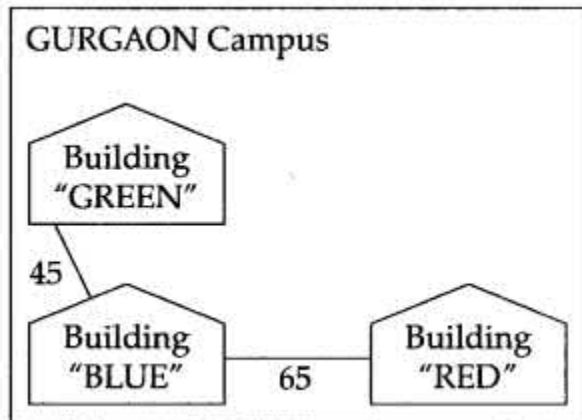

(iii) Since the cabling distance between buildings GREEN, BLUE and RED are quite large, so a repeater, would ideally be needed along their path to avoid loss of signals during the course of data flow in there routes.

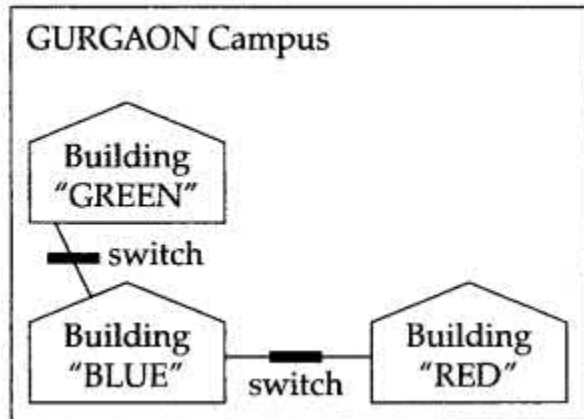

(2) In the layout a switch each would be needed in all the building, to interconnect the group of cables from the different computers in each building.

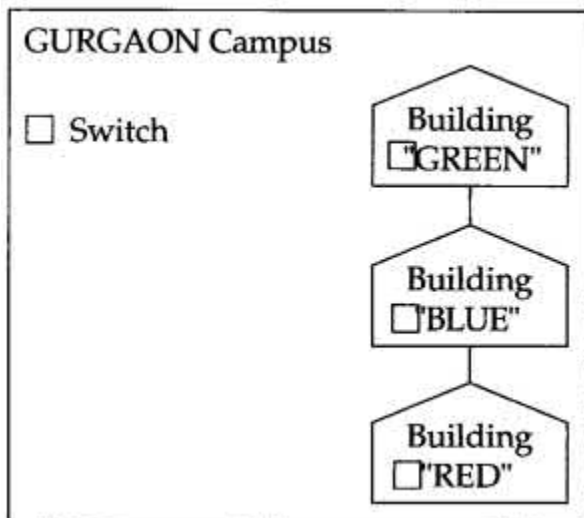

(iv) Optical fibre.

Question 10:

Granuda Consultants are setting up a secured network for their office campus at Faridabad for their day to day office and web based activities. They are planning to have connectivity between 3 building and the head office situated in Kolkata. Answer the questions (i) to (iv) after going through the building positions in the campus and other details, which are given below :

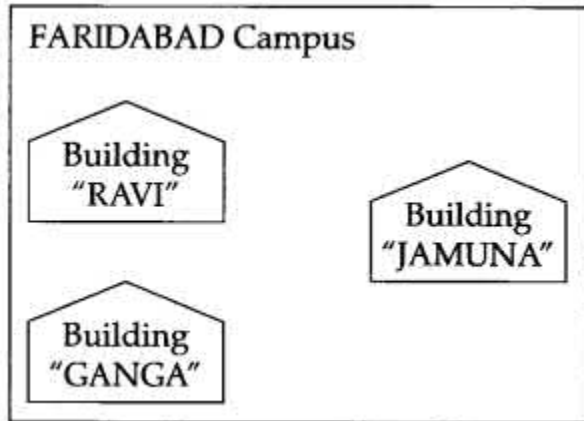

Distances between various buildings :

Building "RAVI" to Building "JAMUNA"	120 m
Building "RAVI" to Building "GANGA"	50 m
Building "GANGA" to Building "JAMUNA"	65 m
Faridabad Campus to Head Office	1460 km

Number of computers

Building "RAVI"	25
Building "JAMUNA"	150
Building "GANGA"	51
Head Office	10

1. Suggest the most suitable place (i.e., block) to house the server of this organization. Also give a reason to justify your suggested location.
2. Suggest a cable layout of connections between the buildings inside the campus.
3. Suggest the placement of the following devices with justification:
 1. Repeater
 2. Switch
4. The organization is planning to provide a high speed link with its head office situated in the KOLKATA using a wired connection. Which of the following cable will be most suitable for this job ?
 1. Optical Fibre
 2. Coaxial Cable
 3. Ethernet Cable

Answer:

(i) The most suitable place to install server is in building "JAMUNA" because this building has maximum computer which reduce the communication delay.

(ii) Cable layout. (Bus topology).

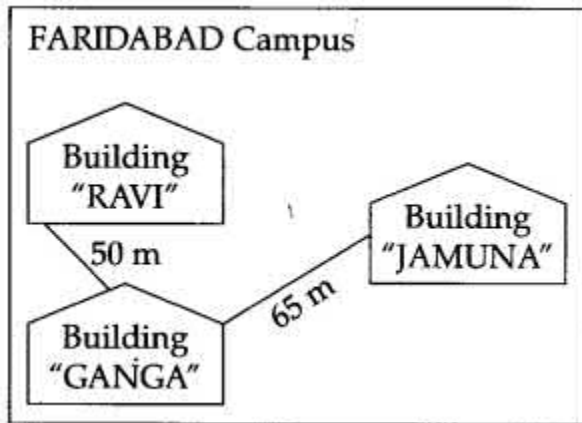

(iii) (1) Since the cabling distance between buildings RAVI, GANGA and JAMUNA are quite large, so a repeater, would ideally be needed along their path to avoid loss of signals during the course of data flow in these routes.

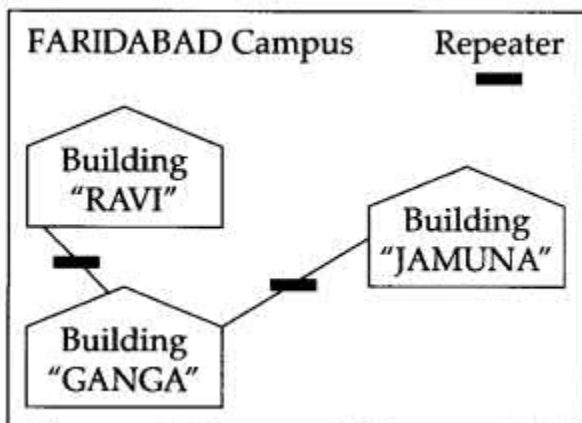

(2) In the layout a switch would be needed in all the building, to interconnect the group of cables from the different computers in each building.

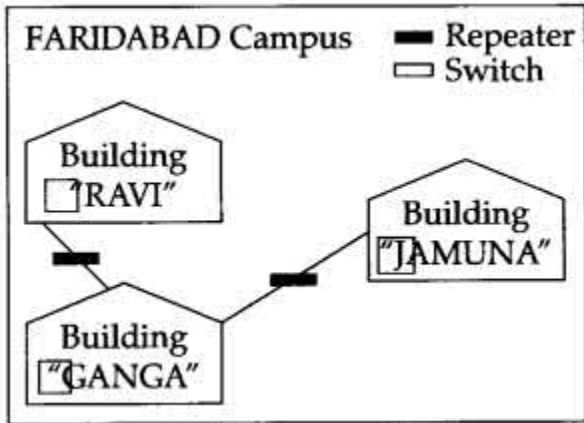

(iv) Optical fibre.

Question 11:

Rehaana Medicos Center has set up its new center in Dubai. It has four buildings as shown in the diagram given below :

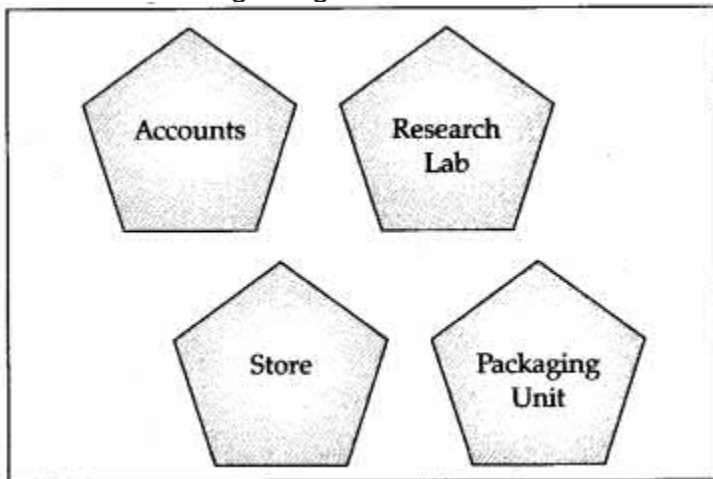

Distances between various buildings are as follows:

Accounts to Research Lab	55 m
Accounts to Store	150 m
Store to Packaging Unit	160 m
Packaging Unit to Research Lab	60 m
Accounts to Packaging Unit	125 m
Store to Research Lab	180 m

Number of computers

Accounts	25
Research Lab	100
Store	15
Packaging Unit	60

As a network expert, provide the best possible answer for the following queries :

1. Suggest a cable layout of connections between the buildings.
2. Suggest the most suitable place (i.e. buildings) to house the server of this organization.
3. Suggest the placement of the following device with justification :
 - (a) Repeater
 - (b) Switch/Hub
4. Suggest a system (hardware/software) to prevent unauthorized access to or from the network.

Answer:

(i) Layout 1

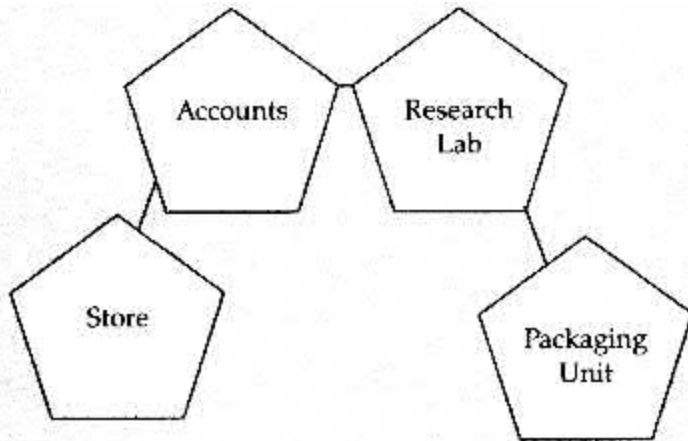

Layout 2

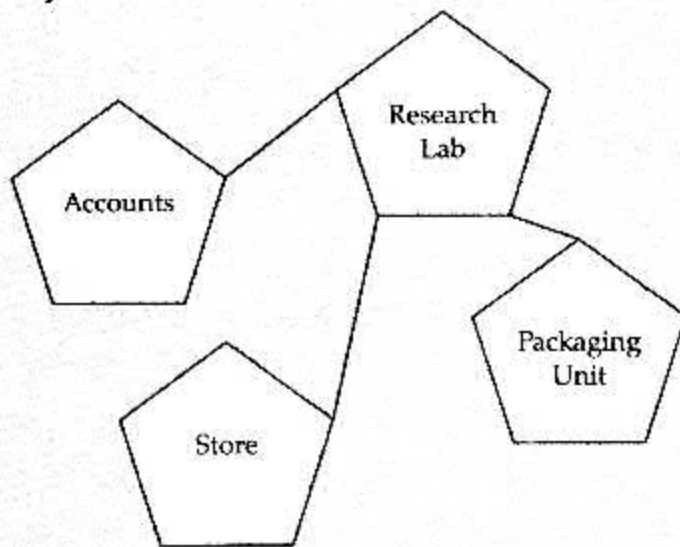

- (ii) The most suitable place/building to house the server of this organization would be in Research Lab, building as this building contains the maximum number of computers.
- (iii) (a) For layout I, since the cabling distance between Accounts to Store is quite large, so a repeater would ideally be needed along their path to avoid loss of signals during the course of data flow in this route. For layout 2, since the cabling distance between Store to Research Lab is quite large, so a repeater would ideally be placed.
- (b) In both the layouts, a Hub/Switch each would be needed in all the buildings to interconnect the group of cables from the different computers in each building.
- (iv) Firewall

Question 12:

Who is a hacker ?

Answer:

A computer enthusiast, who uses his computer . programming skills to intentionally access a computer without authorization is known as hacker. A hacker accesses the computer without the intention of destroying data or maliciously harming the computer.

Question 13:

The following is a 32 bit binary number usually represented as 4 decimal values, each representing 8 bits, in the range 0 to 255 (known as octets) separated by decimal points.

140.179.220.200

What is it? What is its importance?

Answer:

It is an IP Address. It is used to identify the computers on a network.

TOPIC-2

Network Security and Web Service

Very Short Answer Type Questions [1 mark each]

Question 1:

Define firewall

.

Answer:

A system designed to prevent unauthorized access to or from a private network is called a firewall. It can be implemented in both hardware and software or a combination of both.

Question 2:

Write any two examples of Server side Scripts.

Answer:

1. ASP
2. PHP

Question 3:

What is the difference between E-mail & chat?

Answer:

1. Chat occurs in near real time, while E-mail doesn't.
2. Chat is a 2-way communication which requires the permission of both parties, while E-mail is a 1-way communication.

Question 4:

Write names of any two popular open source software, which are used as operating systems.

Answer:

1. Kernels
2. Unix
3. Linux

Question 5:

What is the difference between video conferencing and chat.

Answer:

In conference, we can include more than one person and it allows text, video and audio while chat is one-to-one communication.

Question 6:

Expand the following abbreviations :

1. HTTP
2. VOIP

Answer:

1. HTTP-Hyper Text Transfer Protocol.
2. VOIP-Voice Over Internet Protocol.

Question 7:

What is the difference between HTTP and FTP?

Answer:

Hyper Text Transfer Protocol deals with Transfer of Text and Multimedia content over internet while FTP (File Transfer Protocol) deals with transfer of files over the internet.

Question 8:

What out of the following, will you use to have an audio-visual chat with an expert sitting in a far-away place to fix-up a technical issue ?

1. VOIP
2. Email
3. FTP

Answer:

(i) VOIP

Question 9:

Name one server side scripting language and one client side scripting language.

Answer:

Client Side :

1. JAVASCRIPT
2. VBSCRIPT

Server Side :

1. ASP
2. JSP

Question 10:

Which out of the following comes under cyber crime ?

1. Operating someone's internet banking account, without his knowledge.
2. Stealing a keyboard from someone's computer.
3. Working on someone's Computer with his/ her permission.

Answer:

(i) Operating someone's internet banking account, without his knowledge.

Question 11:

Name two proprietary softwares along with their application.

Answer:

1. MS-Office – All office applications MS-Word, MS-Excel, MS-PowerPoint.
2. Visual Studio – Visual Basic, Visual C++ softwares for application development.

Question 12:

Name some cyber offences under the IT Act.

Answer:

1. Tampering with computer source documents
2. Hacking.
3. Publishing of information which is obscene in electronic form.

Question 13:

What are the 3 ways of protecting intellectual property ?

Answer:

1. Patents
2. Copyrights
3. Trademark

Question 14:

When a user browses a website, the web server sends a text file to the web browser. What is the name of this ?

Answer:

Cookies.

Short Answer Type Questions – I [2 mark each]

Question 1:

Define the following :

1. Firewall
2. VoIP

Answer:

(i) **Firewall** : A system designed to prevent unauthorized access to or from a private network is called firewall. It can be implemented in both hardware and software or combination of both.

(ii) **VoIP** : Voice -over-Internet Protocol(VoIP) is a methodology and group of technologies for delivering voice communications and multimedia sessions over Internet Protocol(IP) networks, such as the Internet.

Question 2:

Give the full form of the following terms.

1. XML
2. FLOSS
3. HTTP
4. FTP

Answer:

1. XML: Extensible Markup Language.
2. FLOSS: Free-Libre Open Source Software.
3. HTTP: Hyper Text Transfer Protocol.
4. FTP: File Transfer Protocol.

Question 3:

Differentiate between WORM and VIRUS in Computer terminology.

Answer:

VIRUS directly effects the system by corrupting the useful data. A computer virus attaches itself to a program or file enabling it to spread from one computer to another. A worm is similar to a virus by design and is considered to be sub class of a virus. Worm spread from computer to computer, but unlike a virus, it has the capability to travel without any human action.

Abbreviations :**Question 4:**

Expand the following

1. GSM
2. GPRS.

Answer:

1. GSM : Global System for Mobile Communication.
2. GPRS : General Packet Radio Service.

Question 5:

Expand the following abbreviations :

1. HTTP
2. VOIP

Answer:

1. HTTP : Hyper Text Transfer Protocol.
2. VOIP : Voice Over Internet Protocol.

Question 6:

Give the full form of :

1. FOSS
2. HTTP

Answer:

1. FOSS : Free Open Source Software.
2. HTTP : Hyper Text Transfer Protocol.

Question 7:

Write the full forms of the following :

1. GNU
2. XML

Answer:

1. GNU : GNU's Not Unix
2. XML : Extensible Markup Language.

Question 8:

Expand the following terminologies :

1. GSM
2. WLL

Answer:

1. GSM : Global System for Mobile Communication
2. WLL : Wireless Local Loop.

Question 9:

Give the full forms of the following terms :

1. CDMA
2. TDMA
3. FDMA

Answer:

1. CDMA : Code Division Multiple Access
2. TDMA : Time Division Multiple Access
3. FDMA : Frequency Division Multiple Access

Question 10:

Expand the following abbreviations :

1. FTP
2. TCP
3. SMTP
4. VOIP

Answer:

1. FTP : File Transfer Protocol
2. TCP : Transmission Control Protocol.
3. SMTP : Simple Mail Transfer Protocol.
4. VOIP : Voice Over Internet Protocol.

Short Answer Type Questions-II [3 marks each]

Question 1:

Give two examples of PAN and LAN type of networks.

Answer:

PAN	LAN
(i) Personal Area Network (ii) Spans a few meters Example : Bluetooth using 2 moblies and laptops sharing files.	(i) Local Area Network (ii) Spans upto a km. Example : System in a lab in a school, systems at home.

Question 2:

Which protocol helps us to browse through web pages using internet browsers ? Name any one internet browser.

Answer:

HTTP

Google Chrome is a browser

Question 3:

Write two advantages of 4G over 3G Mobile Telecommunication Technologies in terms of speed and services.

Answer:

4G has very high data rates upto 100 Mbps.
It covers a wider range than 3G

Question 1:

Write two characteristics of Web 2.0

Answer:

Web 2.0

1. dynamic and interactive websites
2. Only the changed part is reloaded so faster.